

AlphaEclipse StreetSmart MASTER/SLAVE Sign Connection

<http://www.adaptivedisplays.com/support/eclipse>

This QuickStart gives a brief overview of sign installation.
For complete instructions, see the "AlphaEclipse StreetSmart Sign Installation Manual" (pn 1179600101).

1 Identify the MASTER sign and the SLAVE sign. Locate the label on the back of each sign:



2 On the MASTER sign, locate and open the Control Cube's door:



Use a 5/32-inch hex tool to open each Control Cube door locks (circled).

There are 4 to 6 door locks on a sign door. Each door lock is hexagon shaped:

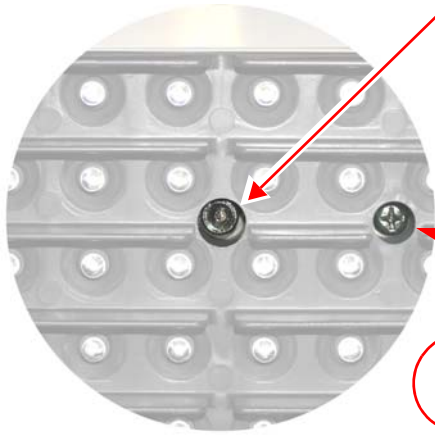

The Control Cube is in the bottom row on the far right side of a sign.

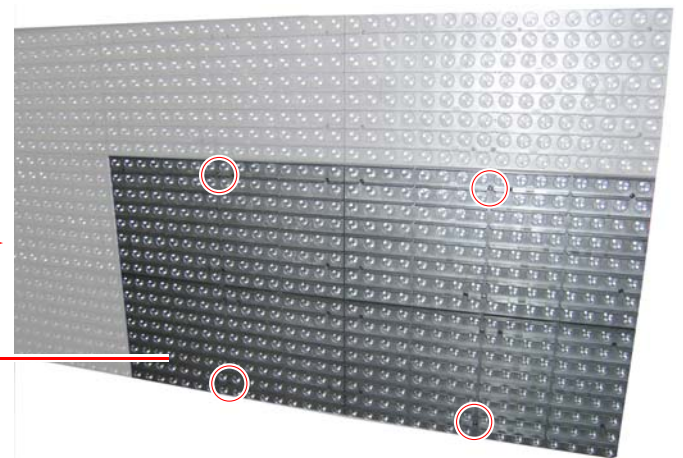

Do NOT remove any of the Phillips head screws. These screws hold the LED boards to the sign door.

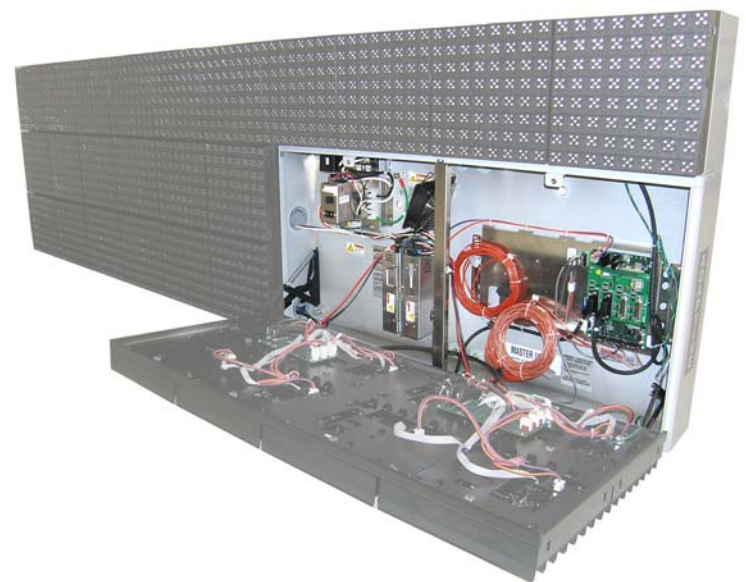

3 Remove the communication cable from the Control Cube:

Communication cable

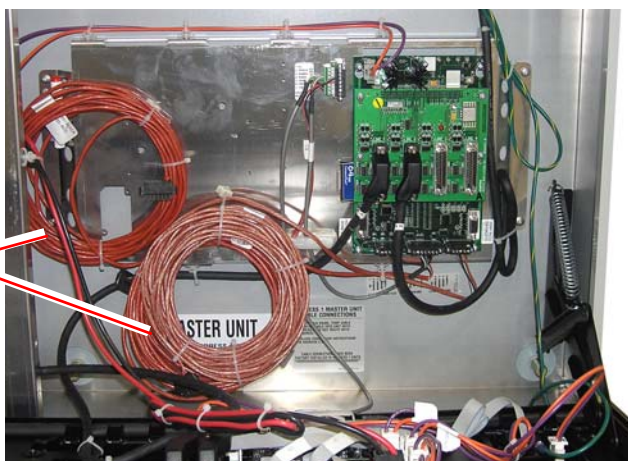

4 There are three, labeled communication cables:

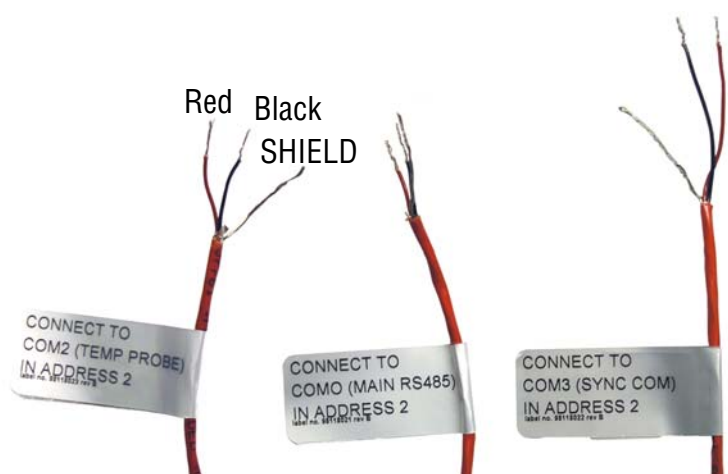

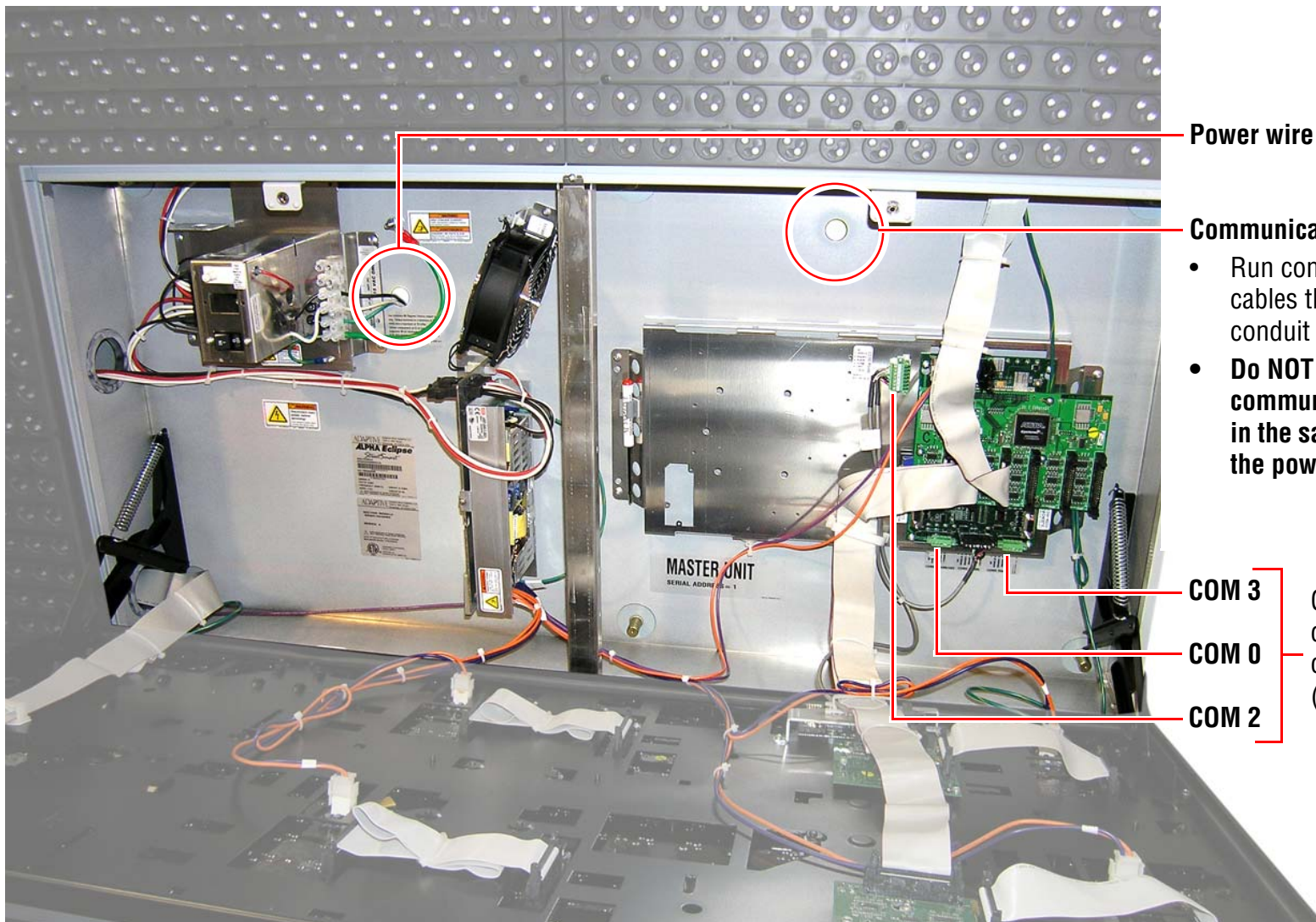
5**Run the three communication cables through one of the conduit openings *under* the controller board:****Power wire conduit hole****Communication conduit hole**

- Run communication cables through this conduit hole.
- **Do NOT run communication cables in the same conduit as the power wires.**

COM 3**COM 0****COM 2**

Connect communication cables to these (see step #6.)

6**Wire the communication cables to the MASTER and SLAVE signs as shown below:**

MASTER UNIT
SERIAL ADDRESS = 1

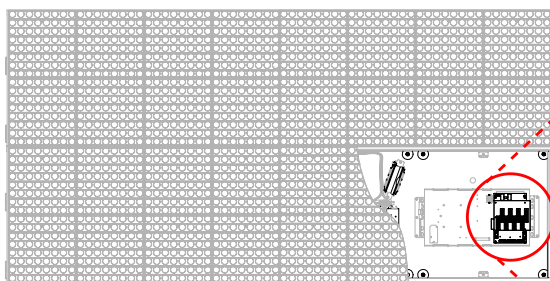

Control cube
(bottom rightmost cube)

SLAVE UNIT
SERIAL ADDRESS = 2

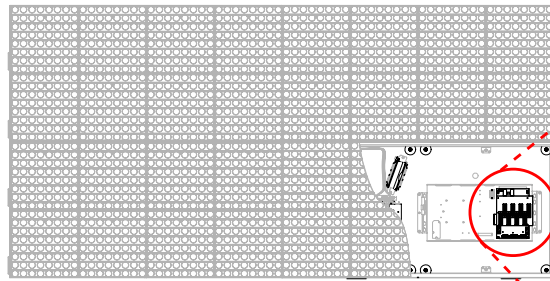

Control cube
(bottom rightmost cube)

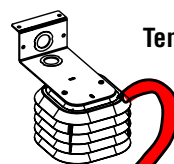
**Temperature probe (optional)**

Mount the probe to a light-colored surface at least 6 feet above ground and **not** in direct sunlight.

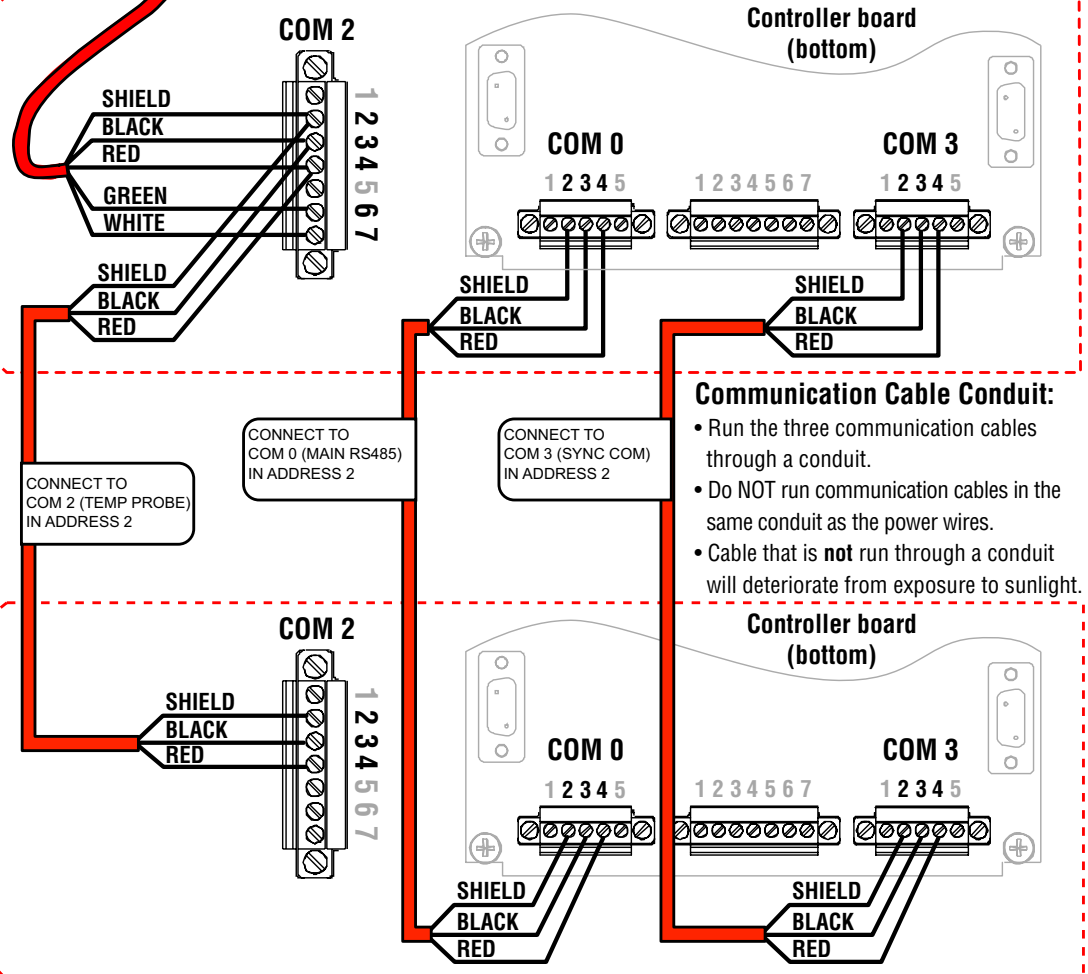
**7****Complete the sign installation.**

- See the "AlphaEclipse StreetSmart Sign Installation Manual" (pn 1179600101).
- Remember to earth ground the sign using the ground lug on the back of the sign.



Ground lug